

3 W filter-free Class D audio power amplifier with 6-12 dB fixed gain select

Features

- Operating range from $V_{CC} = 2.4\text{ V}$ to 5.5 V
- Standby mode active low
- Output power: 1.4 W at 5 V or 0.45 W at 3.0 V into $8\ \Omega$ with 1% THD+N max.
- Output power: 2.3 W at 5 V or 0.75 W at 3.0 V into $4\ \Omega$ with 1% THD+N max.
- Fixed gain select: 6 dB or 12 dB
- Low current consumption
- Efficiency: 88% typ.
- Signal-to-noise ratio: 94 dB typ.
- PSRR: 63 dB typ at 217 Hz with 6 dB gain
- PWM base frequency: 280 kHz
- Low pop & click noise
- Thermal shutdown protection
- DFN8 3 x 3 mm package

Applications

- Cellular phones
- PDAs
- Notebook PCs

Description

The TS2007 is a class D power audio amplifier. Able to drive up to 1.4 W into an $8\ \Omega$ load at 5 V , it achieves outstanding efficiency compared to typical class AB audio power amplifiers.

This device allows switching between two different gains: 6 or 12dB via a logic signal on the GS pin. A pop & click reduction circuitry provides low on/off switching noise while allowing the device to start within 5 ms. A standby function (active low) allows lowering the current consumption down to 10 nA typ.

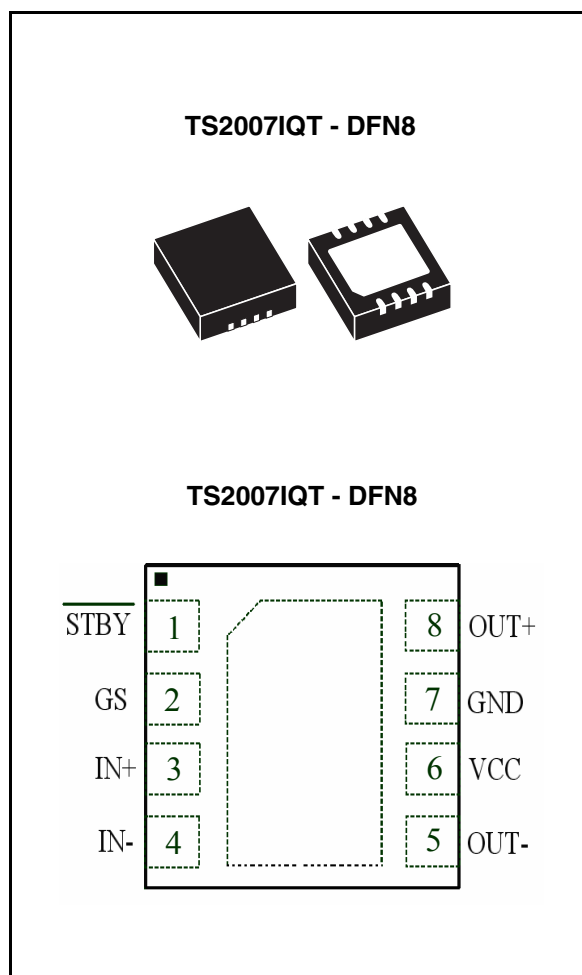

The TS2007 is available in DFN8 3 x 3 mm lead-free packages.

Contents

- 1 Absolute maximum ratings and operating conditions 3**
- 2 Typical application 4**
- 3 Electrical characteristics 6**
 - 3.1 Electrical characteristic tables 6
 - 3.2 Electrical characteristic curves 12
- 4 Application information 22**
 - 4.1 Differential configuration principle 22
 - 4.2 Gain settings 22
 - 4.3 Common-mode feedback loop limitations 22
 - 4.4 Low frequency response 22
 - 4.5 Decoupling of the circuit 23
 - 4.6 Wake-up time (t_{wu}) 23
 - 4.7 Shutdown time 24
 - 4.8 Consumption in shutdown mode 24
 - 4.9 Single-ended input configuration 24
 - 4.10 Output filter considerations 25
- 5 Package information 26**
- 6 Ordering information 28**
- 7 Revision history 28**

1 Absolute maximum ratings and operating conditions

Table 1. Absolute maximum ratings

Symbol	Parameter	Value	Unit
V_{CC}	Supply voltage ⁽¹⁾	6	V
V_i	Input voltage ⁽²⁾	GND to V_{CC}	V
T_{oper}	Operating free air temperature range	-40 to + 85	°C
T_{stg}	Storage temperature	-65 to +150	°C
T_j	Maximum junction temperature	150	°C
R_{thja}	Thermal resistance junction to ambient ⁽³⁾	200	°C/W
P_d	Power dissipation	Internally limited ⁽⁴⁾	
ESD	HBM: human body model	2	kV
ESD	MM: machine model	200	V
Latch-up	Latch-up immunity	Class A	
	Lead temperature (soldering, 10 sec)	260	°C
R_L	Minimum load resistor	3.2	Ω

1. All voltage values are measured with respect to the ground pin.
2. The magnitude of the input signal must never exceed $V_{CC} + 0.3 \text{ V} / \text{GND} - 0.3 \text{ V}$.
3. The device is protected in case of over temperature by a thermal shutdown active @ 150 °C.
4. Exceeding the power derating curves during a long period will cause abnormal operation.

Table 2. Operating conditions

Symbol	Parameter	Value	Unit
V_{CC}	Supply voltage	2.4 to 5.5	V
V_I	Input voltage range	GND to V_{CC}	V
V_{ic}	Input common mode voltage ⁽¹⁾	GND+0.15 V to V_{CC} -0.7 V	V
V_{STBY}	Standby voltage input ⁽²⁾ Device ON Device OFF	$1.4 \leq V_{STBY} \leq V_{CC}$ $\text{GND} \leq V_{STBY} \leq 0.4$ ⁽³⁾	V
GS	Gain select input: Gain = 12dB Gain = 6dB	$\text{GND} \leq V_{GS} \leq 0.4$ $1.4 \leq V_{GS} \leq V_{CC}$	V
R_L	Load resistor	≥ 4	Ω
R_{thja}	Thermal resistance junction to ambient ⁽⁴⁾	40	°C/W

1. $|V_{oo}| \leq 35 \text{ mV}$ max with both differential gains.
2. Without any signal on V_{STBY} , the device is in standby (internal 300 k Ω pull down resistor).
3. Minimum current consumption is obtained when $V_{STBY} = \text{GND}$.
4. When mounted on 4-layer PCB.

2 Typical application

Figure 1. Typical application schematics

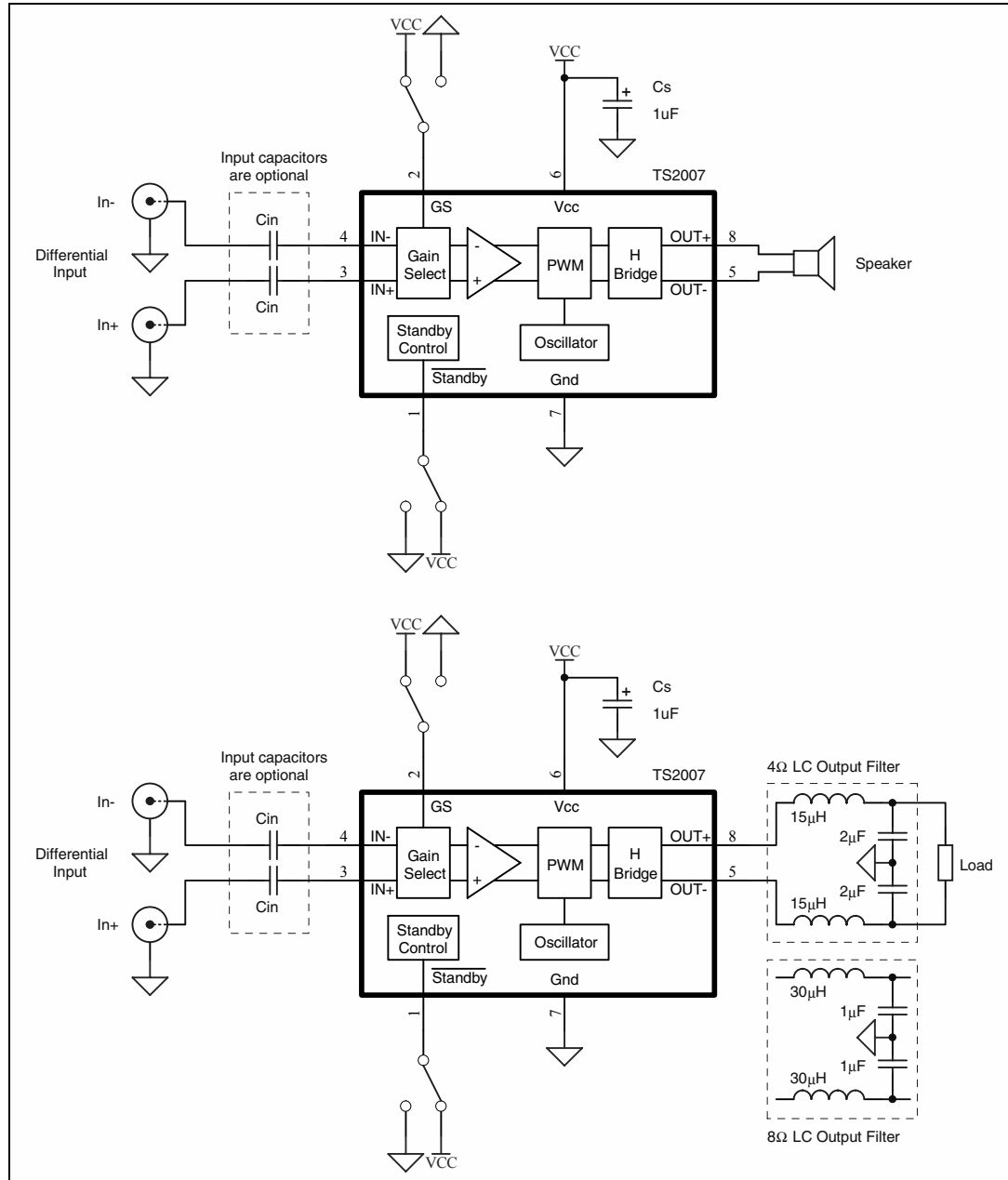

Table 3. External component descriptions

Components	Functional description
C _S	Supply capacitor that provides power supply filtering.
C _{in}	Input coupling capacitors (optional) that block the DC voltage at the amplifier input terminal. The capacitors also form a high pass filter with Z _{in} ($F_{cl} = 1 / (2 \times \text{Pi} \times Z_{in} \times C_{in})$).

Table 4. Pin descriptions

Pin number	Pin name	Pin description
1	STBY	Standby pin (active low)
2	GS	Gain select input
3	IN+	Positive differential input
4	IN-	Negative differential input
5	OUT-	Negative differential output
6	VCC	Power supply
7	GND	Ground
8	OUT+	Positive differential output

3 Electrical characteristics

3.1 Electrical characteristic tables

Table 5. $V_{CC} = +5\text{ V}$, $GND = 0\text{ V}$, $V_{IC}=2.5\text{ V}$, $T_{amb} = 25\text{ }^{\circ}\text{C}$ (unless otherwise specified)

Symbol	Parameter	Min.	Typ.	Max.	Unit
I_{CC}	Supply current No input signal, no load		2.3	3.3	mA
$I_{CC-STBY}$	Standby current ⁽¹⁾ No input signal, $V_{STBY} = GND$		10	1000	nA
V_{oo}	Output offset voltage Floating inputs, $R_L = 8\Omega$			25	mV
P_o	Output power THD = 1% max, $f = 1\text{ kHz}$, $R_L = 4\ \Omega$ THD = 1% max, $f = 1\text{ kHz}$, $R_L = 8\ \Omega$ THD = 10% max, $f = 1\text{ kHz}$, $R_L = 4\ \Omega$ THD = 10% max, $f = 1\text{ kHz}$, $R_L = 8\ \Omega$		2.3 1.4 2.8 1.7		W
THD + N	Total harmonic distortion + noise $P_o = 1W_{RMS}$, $G = 6\text{ dB}$, $f = 1\text{ kHz}$, $R_L = 8\ \Omega$		0.4		%
Efficiency	Efficiency $P_o = 2.1\text{ W}_{RMS}$, $R_L = 4\ \Omega$ (with LC output filter) $P_o = 1.3\text{ W}_{RMS}$, $R_L = 8\ \Omega$ (with LC output filter)		84 90		%
PSRR	Power supply rejection ratio with inputs grounded, $C_{in}=1\mu\text{F}$ ⁽²⁾ $f = 217\text{ Hz}$, $R_L = 8\ \Omega$, Gain=6 dB, $V_{ripple} = 200\text{ mV}_{pp}$ $f = 217\text{ Hz}$, $R_L = 8\ \Omega$, Gain=12 dB, $V_{ripple} = 200\text{ mV}_{pp}$		63 60		dB
CMRR	Common mode rejection ratio $20\text{ Hz} < f < 20\text{ kHz}$		60		dB
Gain	Gain value $G_S = 0\text{ V}$ $G_S = V_{CC}$	11.5 5.5	12 6	12.5 6.5	dB
Z_{in}	Single input impedance ⁽³⁾	68	75	82	k Ω
F_{PWM}	Pulse width modulator base frequency	190	280	370	kHz
SNR	Signal-to-noise ratio (A-weighting) $P_o=1.5\text{ W}$, $R_L=4\ \Omega$ (with LC output filter)		94		dB
t_{WU}	Wake-up time		5	10	ms

Table 5. $V_{CC} = +5\text{ V}$, $GND = 0\text{ V}$, $V_{IC} = 2.5\text{ V}$, $T_{amb} = 25\text{ }^{\circ}\text{C}$ (unless otherwise specified) (continued)

Symbol	Parameter	Min.	Typ.	Max.	Unit
t_{STBY}	Standby time		5		ms
V_N	Output voltage noise $f = 20\text{ Hz to } 20\text{ kHz}$, $R_L = 4\ \Omega$				μV_{RMS}
	Unweighted (Filterless, $G=6\text{ dB}$)		74		
	A-weighted (Filterless, $G=6\text{ dB}$)		50		
	Unweighted (with LC output filter, $G=6\text{ dB}$)		69		
	A-weighted (with LC output filter, $G=6\text{ dB}$)		49		
	Unweighted (Filterless, $G=12\text{ dB}$)		94		
	A-weighted (Filterless, $G=12\text{ dB}$)		65		
Unweighted (with LC output filter, $G=12\text{ dB}$)		86			
A-weighted (with LC output filter, $G=12\text{ dB}$)		64			

- Standby mode is active when V_{STBY} is tied to GND.
- Dynamic measurements - $20 \cdot \log(\text{rms}(V_{out})/\text{rms}(V_{ripple}))$. V_{ripple} is the superimposed sinus signal to V_{CC} @ $f = 217\text{ Hz}$.
- Independent of Gain configuration (6 or 12 dB) and between IN+ or IN- and GND.

Table 6. $V_{CC} = +4.2\text{ V}$, $GND = 0\text{ V}$, $V_{IC}=2.1\text{ V}$, $T_{amb} = 25\text{ }^\circ\text{C}$ (unless otherwise specified)⁽¹⁾

Symbol	Parameter	Min.	Typ.	Max.	Unit
I_{CC}	Supply current No input signal, no load		2.1	3	mA
$I_{CC-STBY}$	Standby current ⁽²⁾ No input signal, $V_{STBY} = GND$		10	1000	nA
V_{oo}	Output offset voltage Floating inputs, $R_L = 8\ \Omega$			25	mV
P_o	Output power THD = 1% max, $f = 1\text{ kHz}$, $R_L = 4\ \Omega$ THD = 1% max, $f = 1\text{ kHz}$, $R_L = 8\ \Omega$ THD = 10% max, $f = 1\text{ kHz}$, $R_L = 4\ \Omega$ THD = 10% max, $f = 1\text{ kHz}$, $R_L = 8\ \Omega$		1.6 0.95 1.95 1.1		W
THD + N	Total harmonic distortion + noise $P_o = 800\text{ mW}_{RMS}$, $G = 6\text{ dB}$, $f = 1\text{ kHz}$, $R_L = 8\ \Omega$		0.45		%
Efficiency	Efficiency $P_o = 1.5\text{ W}_{RMS}$, $R_L = 4\ \Omega$ (with LC output filter) $P_o = 0.95\text{ W}_{RMS}$, $R_L = 8\ \Omega$ (with LC output filter)		85 90		%
PSRR	Power supply rejection ratio with inputs grounded, $C_{in} = 1\ \mu\text{F}$ ⁽³⁾ $f = 217\text{ Hz}$, $R_L = 8\ \Omega$, $\text{Gain} = 6\text{ dB}$, $V_{ripple} = 200\text{ mV}_{pp}$ $f = 217\text{ Hz}$, $R_L = 8\ \Omega$, $\text{Gain} = 12\text{ dB}$, $V_{ripple} = 200\text{ mV}_{pp}$		63 60		dB
CMRR	Common mode rejection ratio $20\text{ Hz} < f < 20\text{ kHz}$		60		dB
Gain	Gain value $G_S = 0\text{ V}$ $G_S = V_{CC}$	11.5 5.5	12 6	12.5 6.5	dB
Z_{in}	Single input impedance ⁽⁴⁾	68	75	82	k Ω
F_{PWM}	Pulse width modulator base frequency	190	280	370	kHz
SNR	Signal-to-noise ratio (A-weighting) $P_o=1.2\text{ W}$, $R_L=4\ \Omega$ (with LC output filter)		93		dB
t_{WU}	Wake-up time		5	10	ms
t_{STBY}	Standby time		5		ms
V_N	Output voltage noise $f = 20\text{ Hz}$ to 20 kHz , $R_L=4\ \Omega$ Unweighted (Filterless, $G=6\text{ dB}$) A-weighted (Filterless, $G=6\text{ dB}$) Unweighted (with LC output filter, $G=6\text{ dB}$) A-weighted (with LC output filter, $G=6\text{ dB}$) Unweighted (Filterless, $G=12\text{ dB}$) A-weighted (Filterless, $G=12\text{ dB}$) Unweighted (with LC output filter, $G=12\text{ dB}$) A-weighted (with LC output filter, $G=12\text{ dB}$)		72 50 68 49 93 65 85 64		μV_{RMS}

1. All electrical values are guaranteed with correlation measurements at 2.4 V and 5 V.
2. Standby mode is active when V_{STBY} is tied to GND.
3. Dynamic measurements - $20 \cdot \log(\text{rms}(V_{out})/\text{rms}(V_{ripple}))$. V_{ripple} is the superimposed sinus signal to V_{CC} @ $f = 217\text{ Hz}$.
4. Independent of Gain configuration (6 or 12 dB) and between IN+ or IN- and GND.

Table 7. $V_{CC} = +3.6\text{ V}$, $GND = 0\text{ V}$, $V_{IC} = 1.8\text{ V}$, $T_{amb} = 25\text{ }^{\circ}\text{C}$ (unless otherwise specified)⁽¹⁾

Symbol	Parameter	Min.	Typ.	Max.	Unit
I_{CC}	Supply current No input signal, no load		2	2.8	mA
$I_{CC-STBY}$	Standby current ⁽²⁾ No input signal, $V_{STBY} = GND$		10	1000	nA
V_{oo}	Output offset voltage Floating inputs, $R_L = 8\ \Omega$			25	mV
P_o	Output power THD+N = 1% max, $f = 1\text{ kHz}$, $R_L = 4\ \Omega$ THD+N = 1% max, $f = 1\text{ kHz}$, $R_L = 8\ \Omega$ THD = 10% max, $f = 1\text{ kHz}$, $R_L = 4\ \Omega$ THD = 10% max, $f = 1\text{ kHz}$, $R_L = 8\ \Omega$		1.1 0.65 1.4 0.85		W
THD + N	Total harmonic distortion + noise $P_o = 500\text{ mW}_{RMS}$, $G = 6\text{ dB}$, $f = 1\text{ kHz}$, $R_L = 8\ \Omega$		0.3		%
Efficiency	Efficiency $P_o = 1.1\text{ W}_{RMS}$, $R_L = 4\ \Omega$ (with LC output filter) $P_o = 0.65\text{ W}_{RMS}$, $R_L = 8\ \Omega$ (with LC output filter)		84 90		%
PSRR	Power supply rejection ratio with inputs grounded, $C_{in} = 1\ \mu\text{F}$ ⁽³⁾ $f = 217\text{ Hz}$, $R_L = 8\ \Omega$, Gain = 6 dB, $V_{ripple} = 200\text{ mV}_{pp}$ $f = 217\text{ Hz}$, $R_L = 8\ \Omega$, Gain = 12 dB, $V_{ripple} = 200\text{ mV}_{pp}$		63 60		dB
CMRR	Common mode rejection ratio 20 Hz < f < 20 kHz		60		dB
Gain	Gain value $G_S = 0\text{ V}$ $G_S = V_{CC}$	11.5 5.5	12 6	12.5 6.5	dB
Z_{in}	Single input impedance ⁽⁴⁾	68	75	82	k Ω
F_{PWM}	Pulse width modulator base frequency	190	280	370	kHz
SNR	Signal-to-noise ratio (A-weighting) $P_o = 0.9\text{ W}$, $R_L = 4\ \Omega$ (with LC output filter)		92		dB
t_{WU}	Wake-up time		5	10	ms
t_{STBY}	Standby time		5		ms
V_N	Output voltage noise $f = 20\text{ Hz}$ to 20 kHz , $R_L = 4\ \Omega$ Unweighted (Filterless, $G=6\text{ dB}$) A-weighted (Filterless, $G=6\text{ dB}$) Unweighted (with LC output filter, $G=6\text{ dB}$) A-weighted (with LC output filter, $G=6\text{ dB}$) Unweighted (Filterless, $G=12\text{ dB}$) A-weighted (Filterless, $G=12\text{ dB}$) Unweighted (with LC output filter, $G=12\text{ dB}$) A-weighted (with LC output filter, $G=12\text{ dB}$)		72 50 68 49 93 65 85 64		μV_{RMS}

1. All electrical values are guaranteed with correlation measurements at 2.4 V and 5 V.

2. Standby mode is active when V_{STBY} is tied to GND.

3. Dynamic measurements - $20 \cdot \log(\text{rms}(V_{out})/\text{rms}(V_{ripple}))$. V_{ripple} is the superimposed sinus signal to V_{CC} @ $f = 217\text{ Hz}$.

4. Independent of Gain configuration (6 or 12 dB) and between IN+ or IN- and GND.

Table 8. $V_{CC} = +3.0\text{ V}$, $GND = 0\text{ V}$, $V_{ic}=1.5\text{ V}$, $T_{amb} = 25\text{ }^{\circ}\text{C}$ (unless otherwise specified)⁽¹⁾

Symbol	Parameter	Min.	Typ.	Max.	Unit
I_{CC}	Supply current No input signal, no load		1.9	2.7	mA
$I_{CC-STBY}$	Standby current ⁽²⁾ No input signal, $V_{STBY} = GND$		10	1000	nA
V_{oo}	Output offset voltage Floating inputs, $R_L = 8\ \Omega$			25	mV
P_o	Output power THD+N = 1% Max, $f = 1\text{ kHz}$, $R_L = 4\ \Omega$ THD+N = 1% Max, $f = 1\text{ kHz}$, $R_L = 8\ \Omega$ THD = 10% Max, $f = 1\text{ kHz}$, $R_L = 4\ \Omega$ THD = 10% Max, $f = 1\text{ kHz}$, $R_L = 8\ \Omega$		0.75 0.45 1 0.6		W
THD + N	Total harmonic distortion + noise $P_o = 400\text{ mW}_{RMS}$, $G = 6\text{ dB}$, $f = 1\text{ kHz}$, $R_L = 8\ \Omega$		0.5		%
Efficiency	Efficiency $P_o = 0.75\text{ W}_{RMS}$, $R_L = 4\ \Omega$ (with LC output filter) $P_o = 0.45\text{ W}_{RMS}$, $R_L = 8\ \Omega$ (with LC output filter)		83 90		%
PSRR	Power supply rejection ratio with inputs grounded, $C_{in} = 1\ \mu\text{F}$ ⁽³⁾ $f = 217\text{ Hz}$, $R_L = 8\ \Omega$, Gain=6 dB, $V_{ripple} = 200\text{ mV}_{pp}$ $f = 217\text{ Hz}$, $R_L = 8\ \Omega$, Gain=12 dB, $V_{ripple} = 200\text{ mV}_{pp}$		63 60		dB
CMRR	Common mode rejection ratio $20\text{ Hz} < f < 20\text{ kHz}$		60		dB
Gain	Gain value $G_S = 0\text{ V}$ $G_S = V_{CC}$	11.5 5.5	12 6	12.5 6.5	dB
Z_{in}	Single input impedance ⁽⁴⁾	68	75	82	k Ω
F_{PWM}	Pulse width modulator base frequency	190	280	370	kHz
SNR	Signal-to-noise ratio (A-weighting) $P_o = 0.6\text{ W}$, $R_L = 4\ \Omega$ (with LC output filter)		90		dB
t_{WU}	Wake-up time		5	10	ms
t_{STBY}	Standby time		5		ms
V_N	Output voltage noise $f = 20\text{ Hz}$ to 20 kHz , $R_L=4\ \Omega$ Unweighted (Filterless, $G=6\text{ dB}$) A-weighted (Filterless, $G=6\text{ dB}$) Unweighted (with LC output filter, $G=6\text{ dB}$) A-weighted (with LC output filter, $G=6\text{ dB}$) Unweighted (Filterless, $G=12\text{ dB}$) A-weighted (Filterless, $G=12\text{ dB}$) Unweighted (with LC output filter, $G=12\text{ dB}$) A-weighted (with LC output filter, $G=12\text{ dB}$)		71 50 67 49 92 65 85 64		μV_{RMS}

1. All electrical values are guaranteed with correlation measurements at 2.4 V and 5 V.

2. Standby mode is active when V_{STBY} is tied to GND.

3. Dynamic measurements - $20 \cdot \log(\text{rms}(V_{out})/\text{rms}(V_{ripple}))$. V_{ripple} is the superimposed sinus signal to V_{CC} @ $f = 217\text{ Hz}$.

4. Independent of Gain configuration (6 or 12 dB) and between IN+ or IN- and GND.

Table 9. $V_{CC} = +2.4\text{ V}$, $GND = 0\text{ V}$, $V_{IC} = 1.2\text{ V}$, $T_{amb} = 25\text{ }^{\circ}\text{C}$ (unless otherwise specified)

Symbol	Parameter	Min.	Typ.	Max.	Unit
I_{CC}	Supply current No input signal, no load		1.7	2.4	mA
$I_{CC-STBY}$	Standby current ⁽¹⁾ No input signal, $V_{STBY} = GND$		10	1000	nA
V_{oo}	Output offset voltage Floating inputs, $R_L = 8\ \Omega$			25	mV
P_o	Output power THD+N = 1% Max, $f = 1\text{ kHz}$, $R_L = 4\ \Omega$ THD+N = 1% Max, $f = 1\text{ kHz}$, $R_L = 8\ \Omega$ THD = 10% Max, $f = 1\text{ kHz}$, $R_L = 4\ \Omega$ THD = 10% Max, $f = 1\text{ kHz}$, $R_L = 8\ \Omega$		0.48 0.3 0.6 0.36		W
THD + N	Total harmonic distortion + noise $P_o = 200\text{ mW}_{RMS}$, $G = 6\text{ dB}$, $f = 1\text{ kHz}$, $R_L = 8\ \Omega$		0.1		%
Efficiency	Efficiency $P_o = 0.38\text{ W}_{RMS}$, $R_L = 4\ \Omega$ (with LC output filter) $P_o = 0.25\text{ W}_{RMS}$, $R_L = 8\ \Omega$ (with LC output filter)		82 90		%
PSRR	Power supply rejection ratio with inputs grounded, $C_{in} = 1\ \mu\text{F}$ ⁽²⁾ $f = 217\text{ Hz}$, $R_L = 8\ \Omega$, Gain=6 dB, $V_{ripple} = 200\text{ mV}_{pp}$ $f = 217\text{ Hz}$, $R_L = 8\ \Omega$, Gain=12 dB, $V_{ripple} = 200\text{ mV}_{pp}$		63 60		dB
CMRR	Common mode rejection ratio $20\text{ Hz} < f < 20\text{ kHz}$		60		dB
Gain	Gain value $G_S = 0\text{ V}$ $G_S = V_{CC}$	11.5 5.5	12 6	12.5 6.5	dB
Z_{in}	Single input impedance ⁽³⁾	68	75	82	k Ω
F_{PWM}	Pulse width modulator base frequency	190	280	370	kHz
SNR	Signal-to-noise ratio (A-weighting) $P_o = 0.4\text{ W}$, $R_L = 4\ \Omega$ (with LC output filter)		88		dB
t_{WU}	Wake-up time		5	10	ms
t_{STBY}	Standby time		5		ms
V_N	Output voltage noise $f = 20\text{ Hz}$ to 20 kHz , $R_L = 4\ \Omega$ Unweighted (filterless, $G=6\text{ dB}$) A-weighted (filterless, $G=6\text{ dB}$) Unweighted (with LC output filter, $G=6\text{ dB}$) A-weighted (with LC output filter, $G=6\text{ dB}$) Unweighted (filterless, $G=12\text{ dB}$) A-weighted (filterless, $G=12\text{ dB}$) Unweighted (with LC output filter, $G=12\text{ dB}$) A-weighted (with LC output filter, $G=12\text{ dB}$)		70 50 66 49 91 65 84 64		μV_{RMS}

1. Standby mode is active when V_{STBY} is tied to GND.

2. Dynamic measurements - $20 \cdot \log(\text{rms}(V_{out})/\text{rms}(V_{ripple}))$. V_{ripple} is the superimposed sinus signal to V_{CC} @ $f = 217\text{ Hz}$.

3. Independent of Gain configuration (6 or 12 dB) and between IN+ or IN- and GND.

3.2 Electrical characteristic curves

The graphs shown in this section use the following abbreviations:

- $R_L + 15\ \mu\text{H}$ or $30\ \mu\text{H}$ = pure resistor + very low series resistance inductor
- Filter = LC output filter ($1\ \mu\text{F} + 30\ \mu\text{H}$ for $4\ \Omega$ and $0.5\ \mu\text{F} + 60\ \mu\text{H}$ for $8\ \Omega$)

All measurements are done with $C_{S1} = 1\ \mu\text{F}$ and $C_{S2} = 100\ \text{nF}$ (see [Figure 2](#), except for the PSRR where C_{S1} is removed (see [Figure 3](#)).

Figure 2. Test diagram for measurements

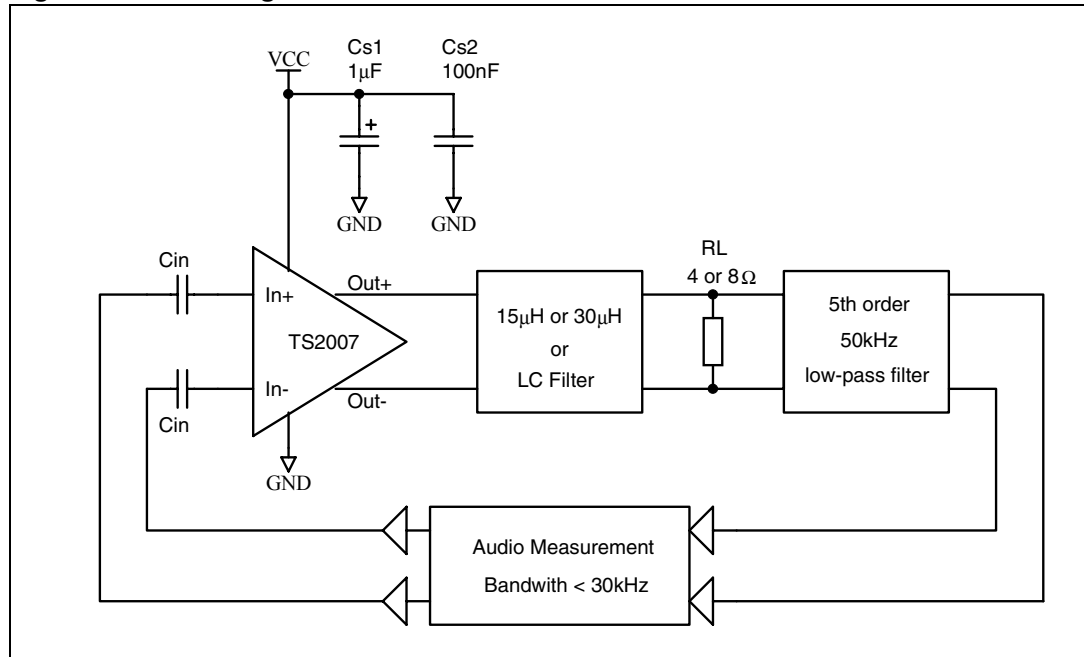

Figure 3. Test diagram for PSRR measurements

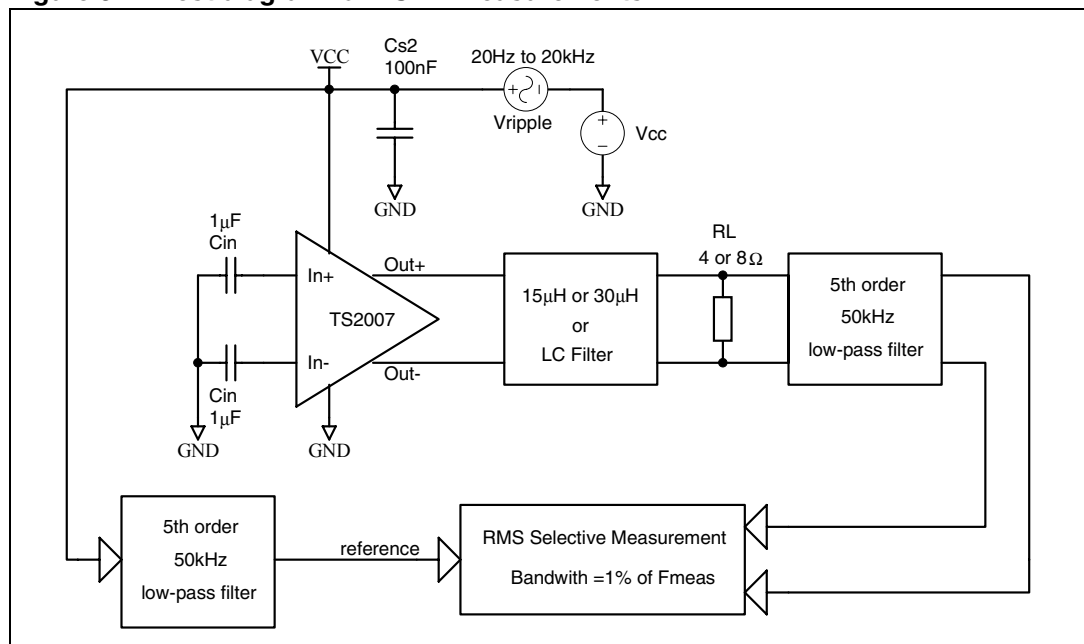

Table 10. Index of graphics

Description	Figure
Current consumption vs. power supply voltage	Figure 4
Current consumption vs. standby voltage	Figure 5
Efficiency vs. output power	Figure 6 - Figure 9
Output power vs. power supply voltage	Figure 10, Figure 11
PSRR vs. common mode input voltage	Figure 12
PSRR vs. frequency	Figure 13 - Figure 17
CMRR vs. common mode input voltage	Figure 18
CMRR vs. frequency	Figure 19 - Figure 23
Gain vs. frequency	Figure 24, Figure 25
THD+N vs. output power	Figure 26 - Figure 33
THD+N vs. frequency	Figure 34 - Figure 45
Power derating curves	Figure 46
Startup and shutdown time	Figure 47 - Figure 49

Figure 4. Current consumption vs. power supply voltage

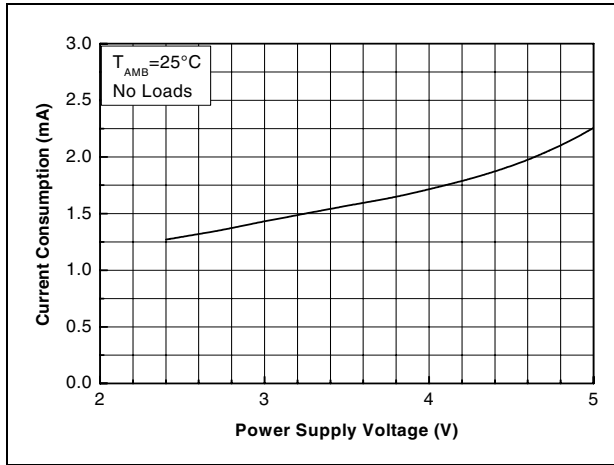

Figure 5. Current consumption vs. standby voltage

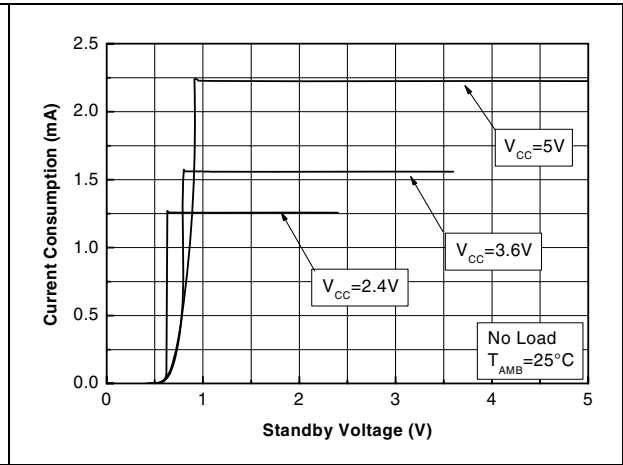

Figure 6. Efficiency vs. output power

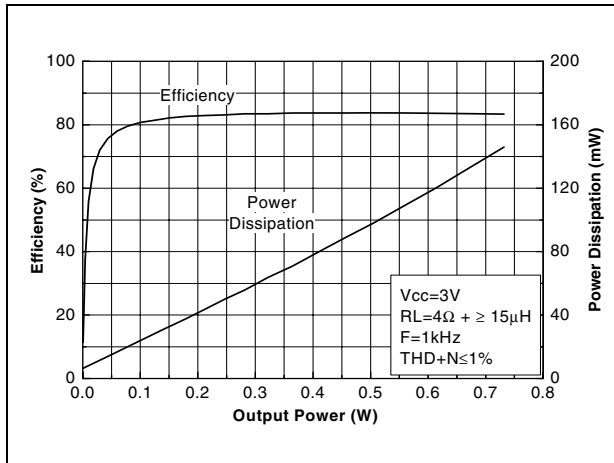

Figure 7. Efficiency vs. output power

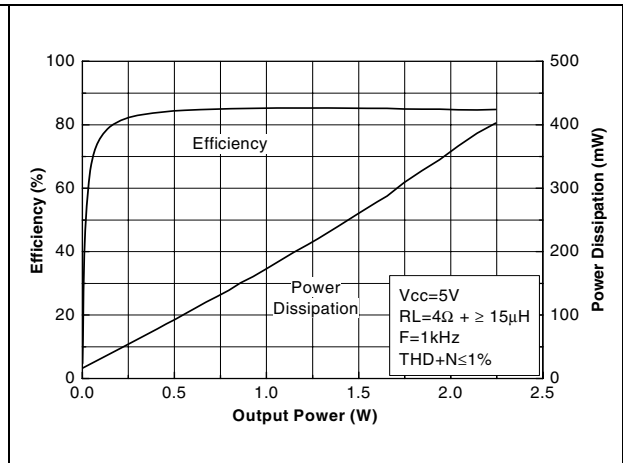

Figure 8. Efficiency vs. output power

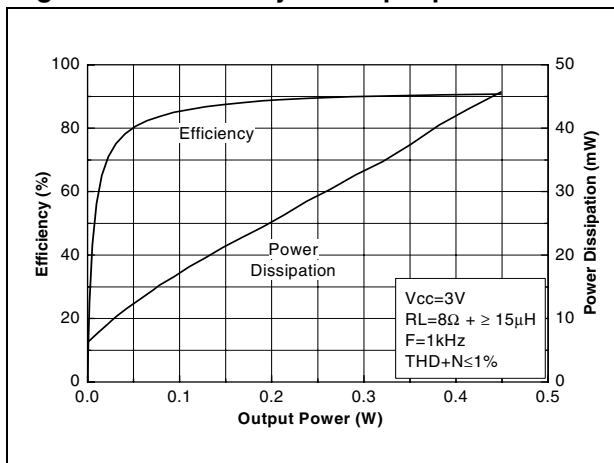

Figure 9. Efficiency vs. output power

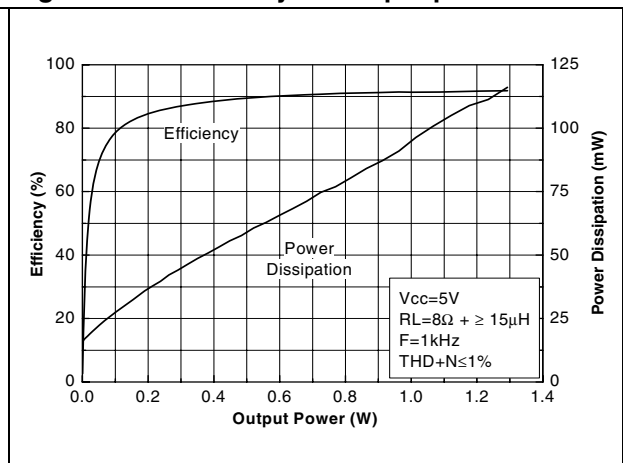

Figure 10. Output power vs. power supply voltage

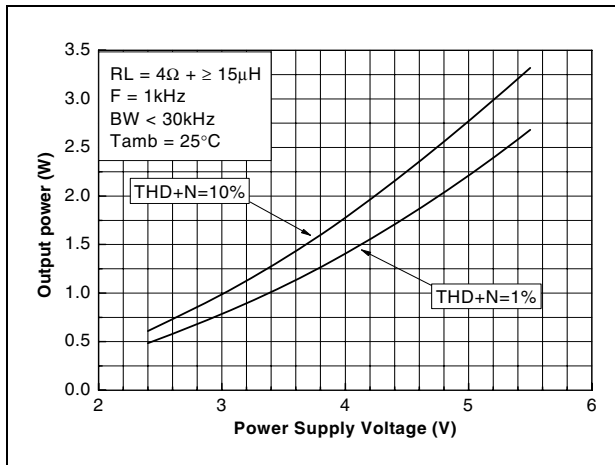

Figure 11. Output power vs. power supply voltage

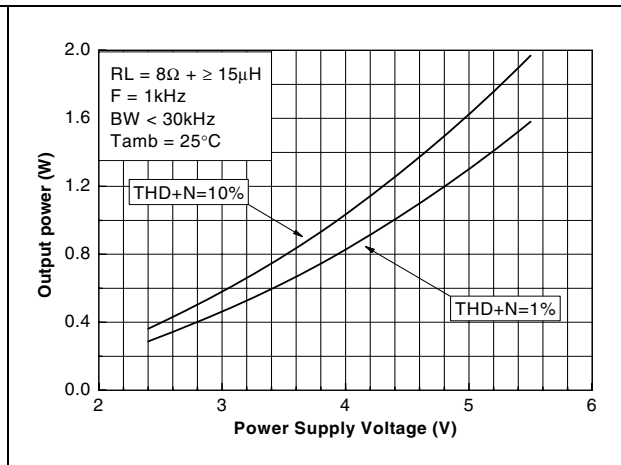

Figure 12. PSRR vs. common mode input voltage

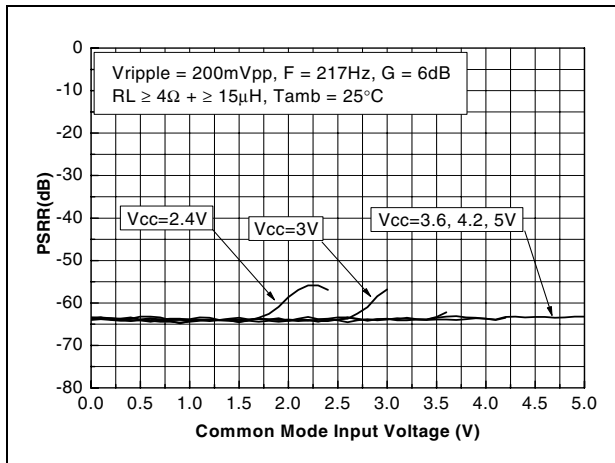

Figure 13. PSRR vs. frequency

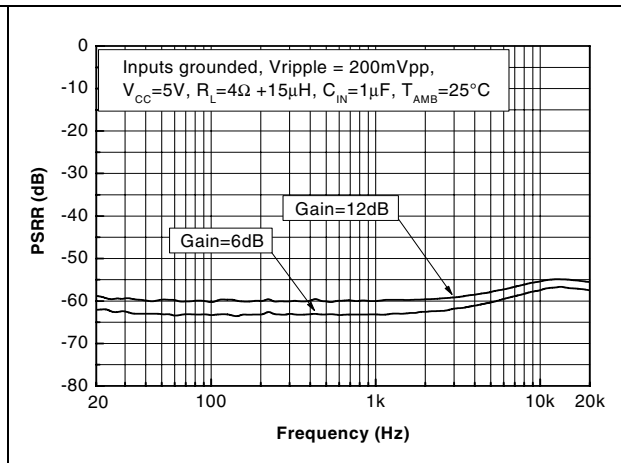

Figure 14. PSRR vs. frequency

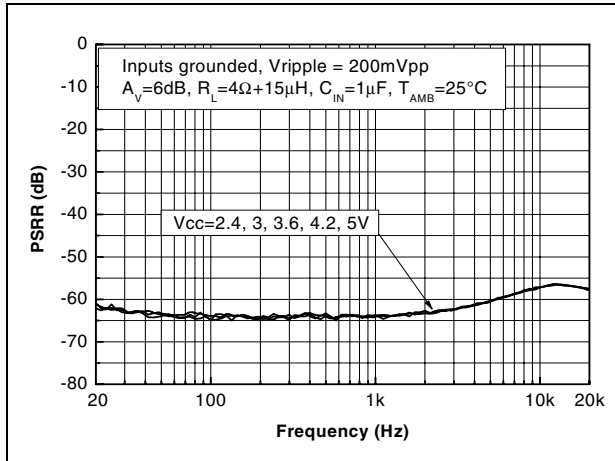

Figure 15. PSRR vs. frequency

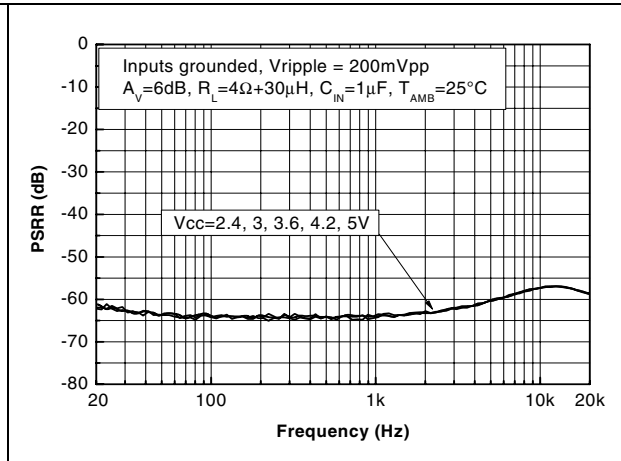

Figure 16. PSRR vs. frequency

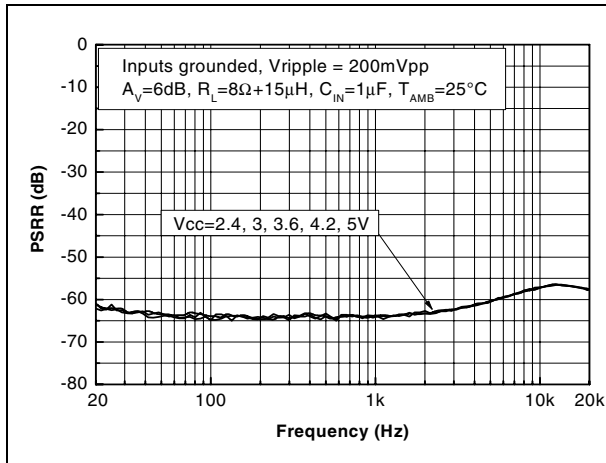

Figure 17. PSRR vs. frequency

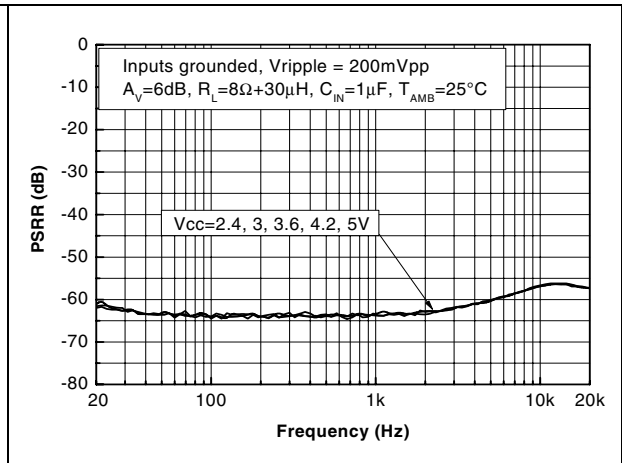

Figure 18. CMRR vs. common mode input voltage

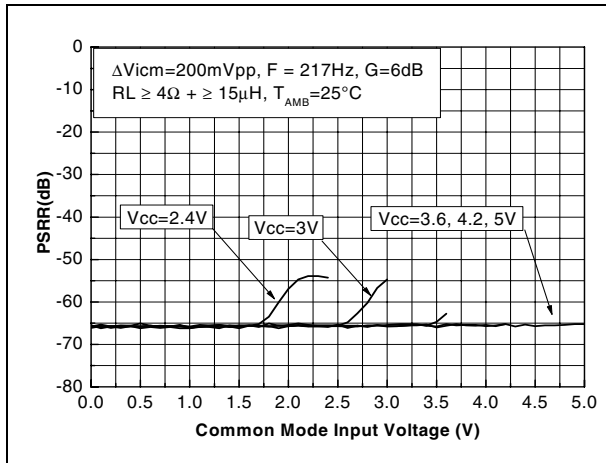

Figure 19. CMRR vs. frequency

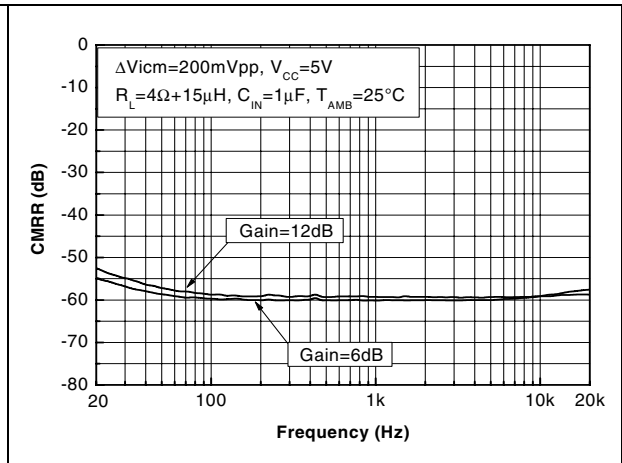

Figure 20. CMRR vs. frequency

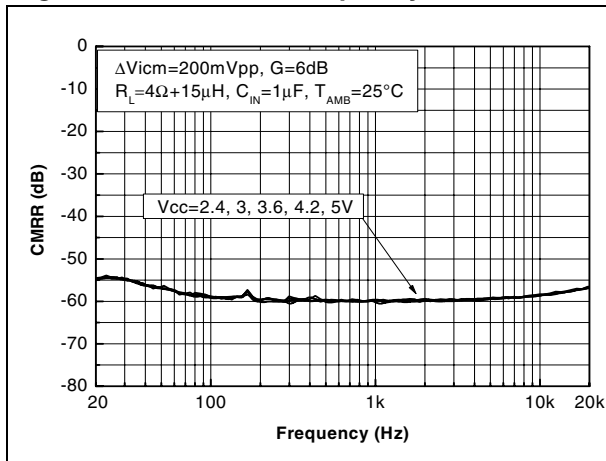

Figure 21. CMRR vs. frequency

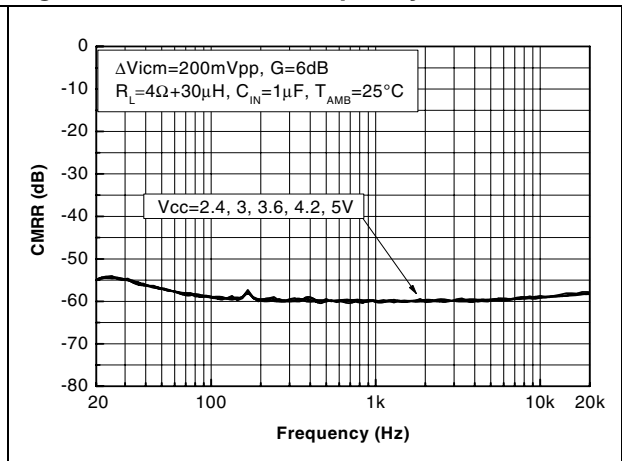

Figure 22. CMRR vs. frequency

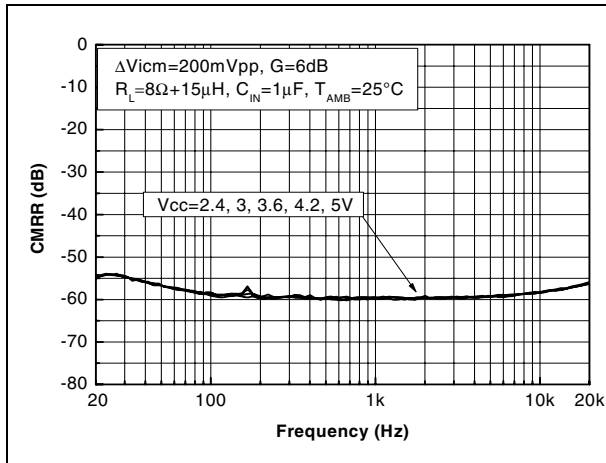

Figure 23. CMRR vs. frequency

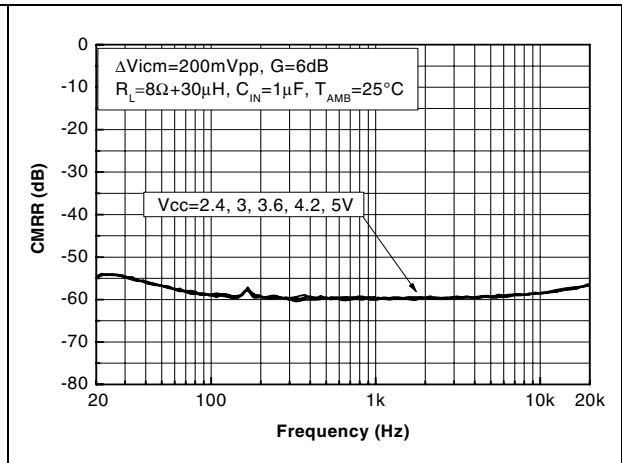

Figure 24. Gain vs. frequency

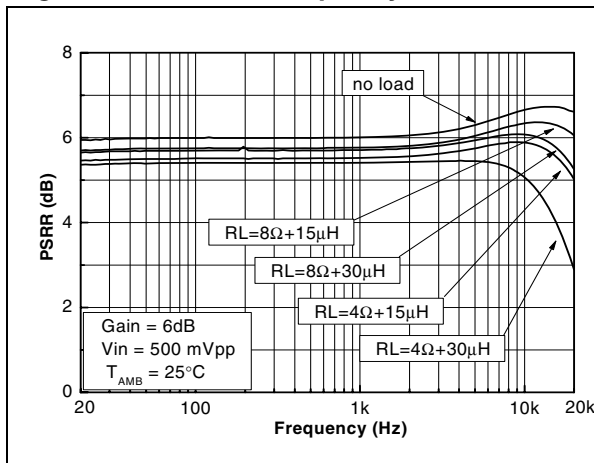

Figure 25. Gain vs. frequency

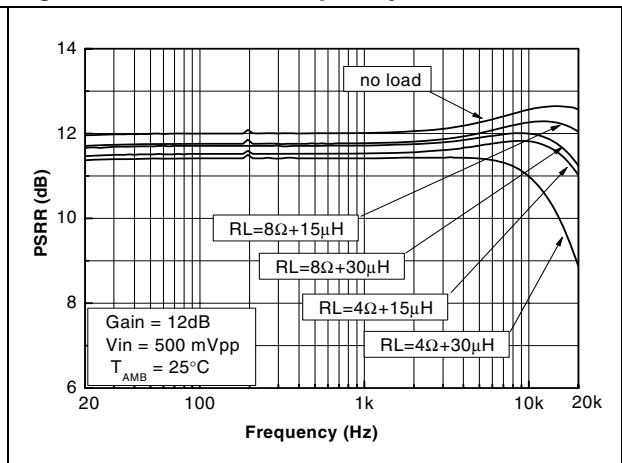

Figure 26. THD+N vs. output power

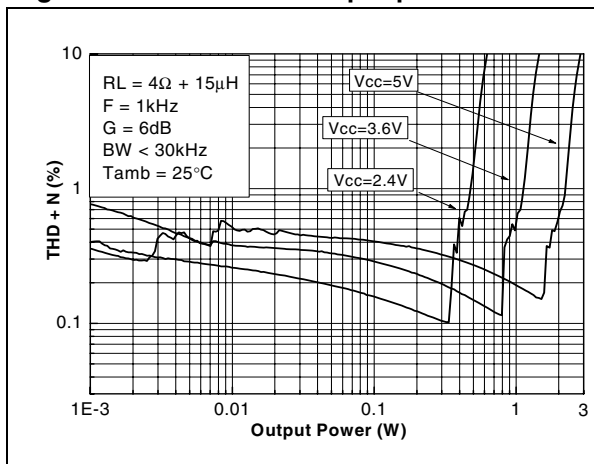

Figure 27. THD+N vs. output power

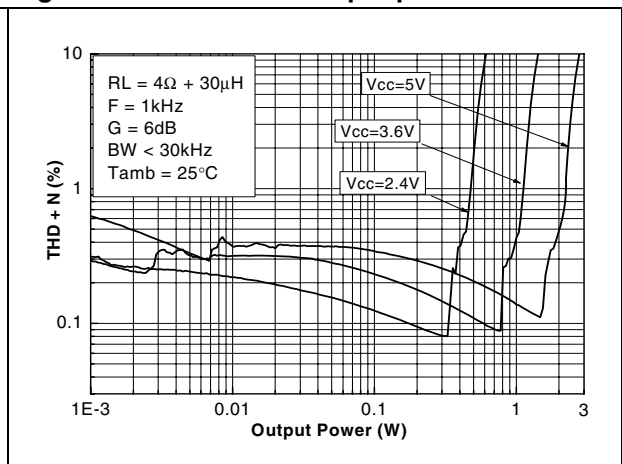

Figure 28. THD+N vs. output power

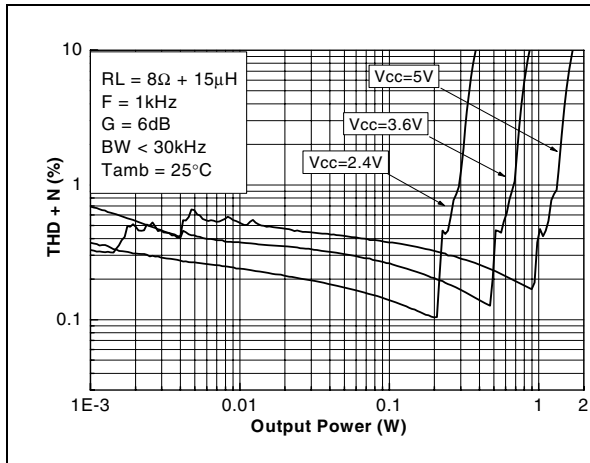

Figure 29. THD+N vs. output power

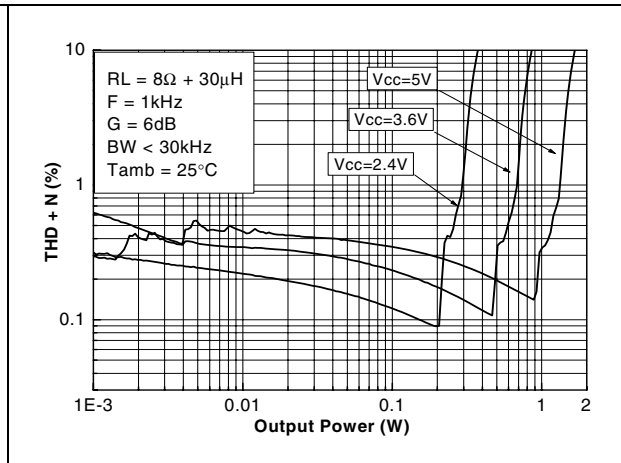

Figure 30. THD+N vs. output power

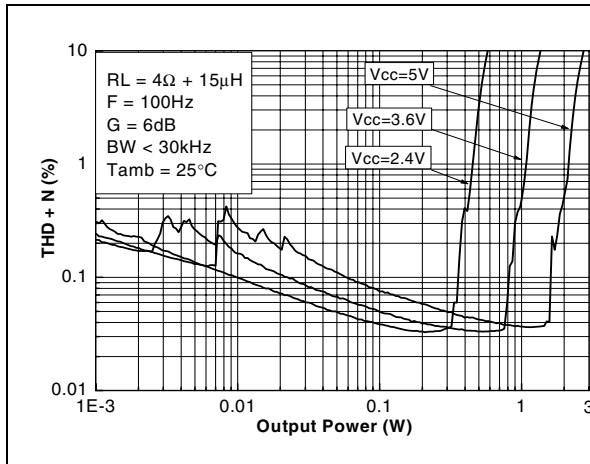

Figure 31. THD+N vs. output power

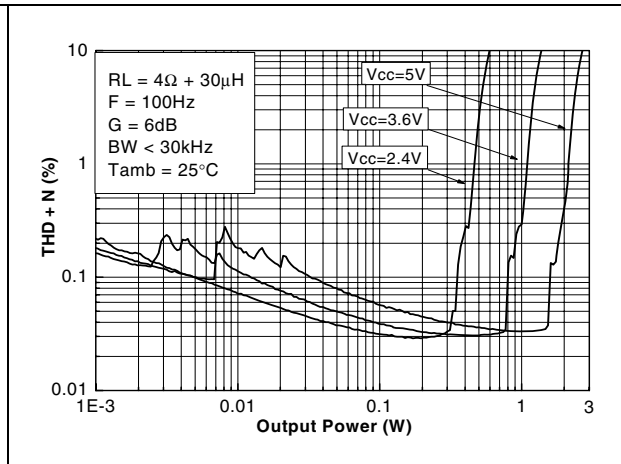

Figure 32. THD+N vs. output power

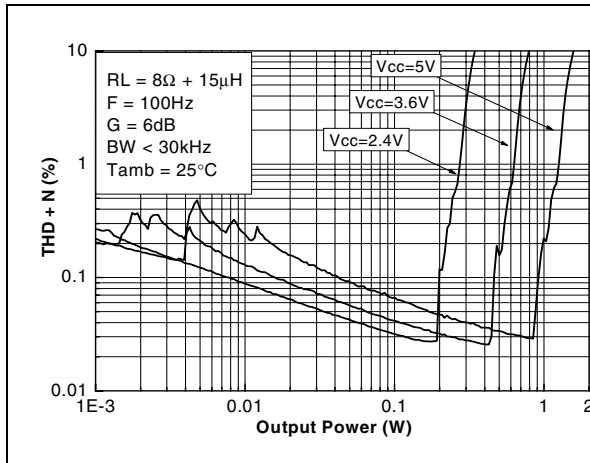

Figure 33. THD+N vs. output power

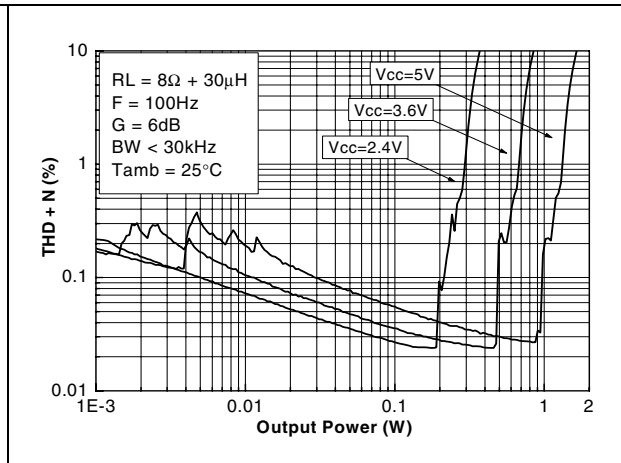

Figure 34. THD+N vs. frequency

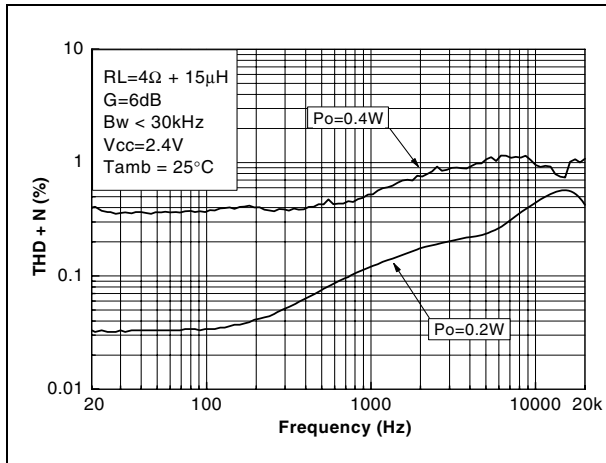

Figure 35. THD+N vs. frequency

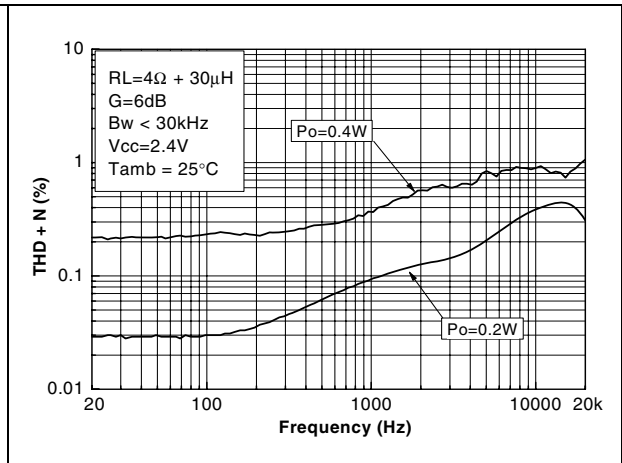

Figure 36. THD+N vs. frequency

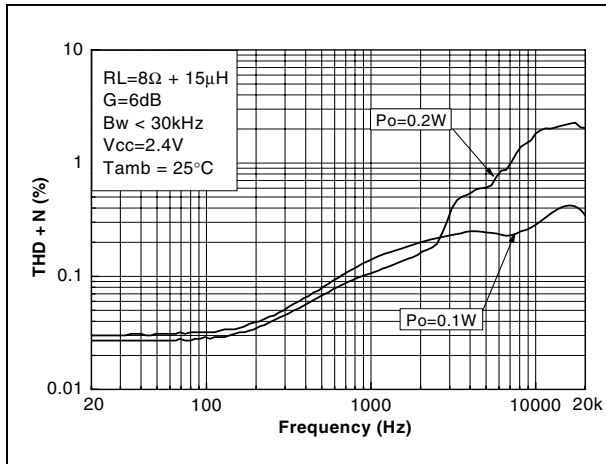

Figure 37. THD+N vs. frequency

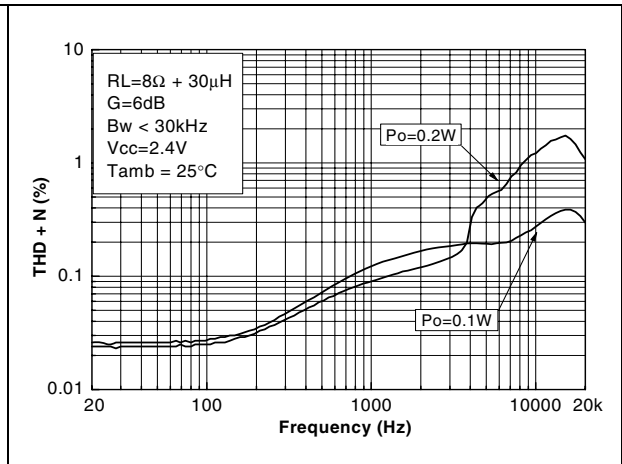

Figure 38. THD+N vs. frequency

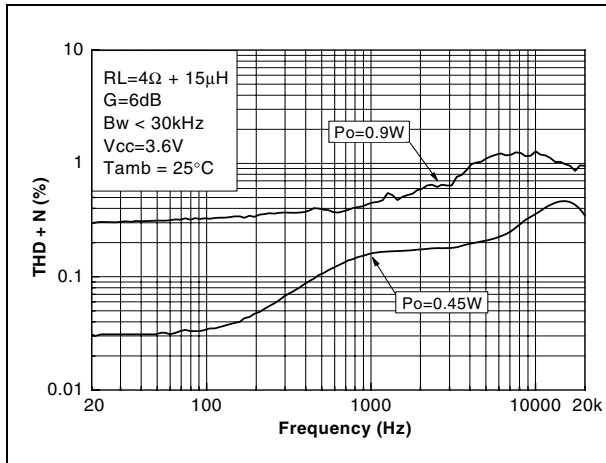

Figure 39. THD+N vs. frequency

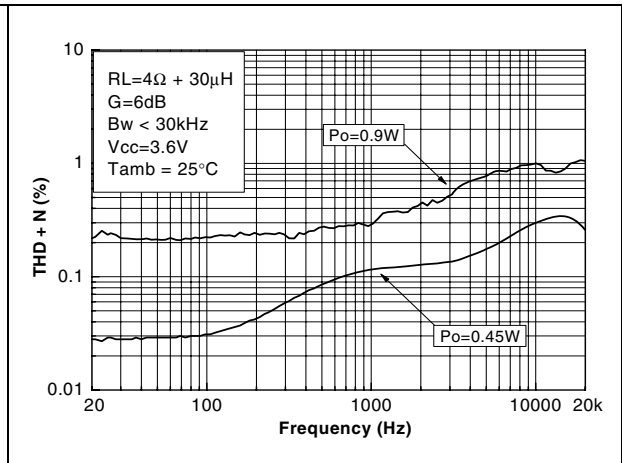

Figure 40. THD+N vs. frequency

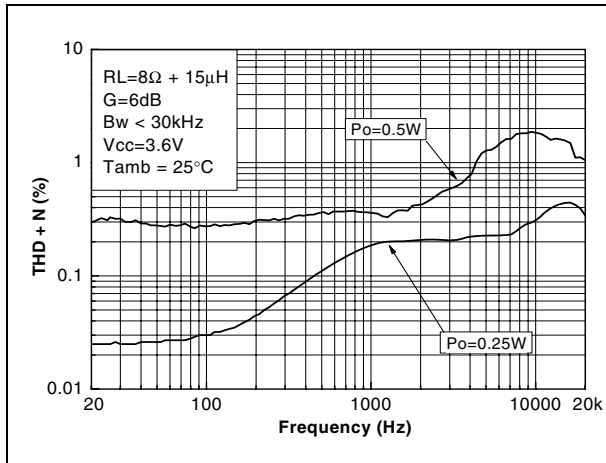

Figure 41. THD+N vs. frequency

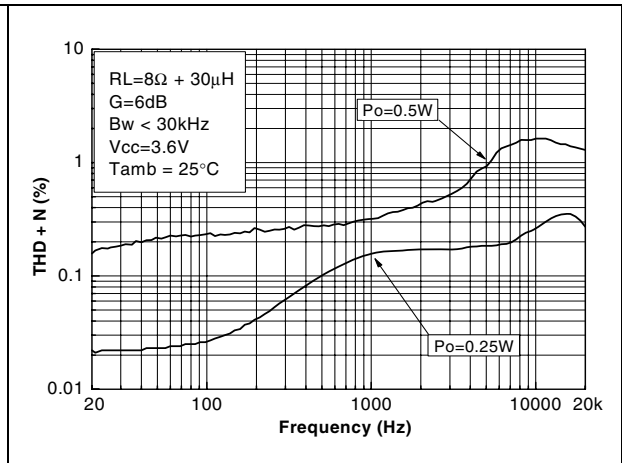

Figure 42. THD+N vs. frequency

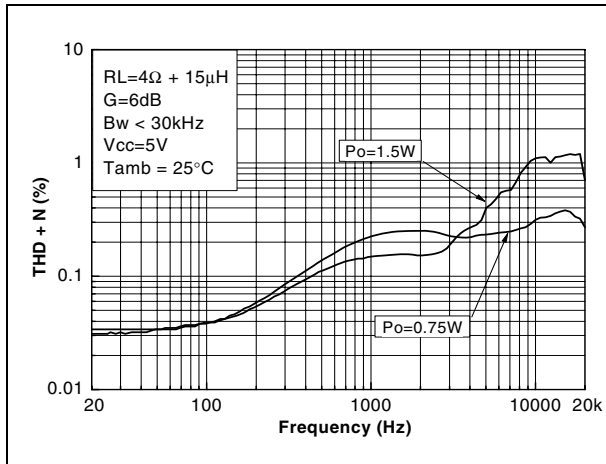

Figure 43. THD+N vs. frequency

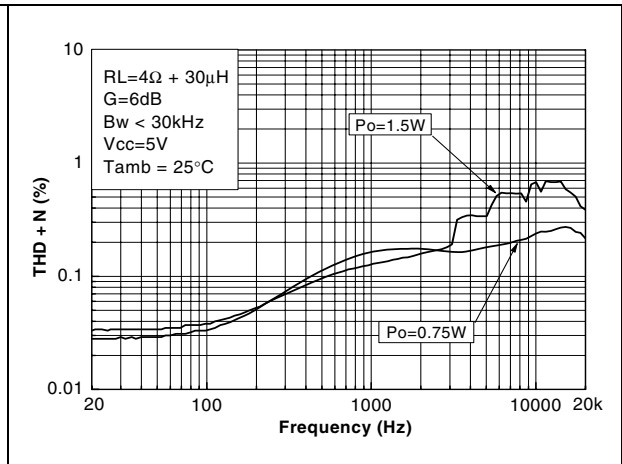

Figure 44. THD+N vs. frequency

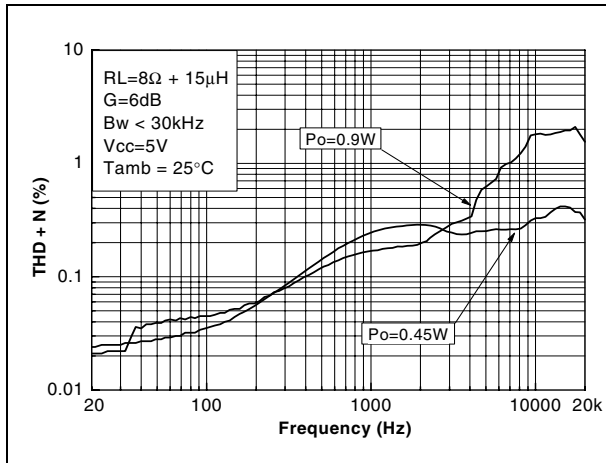

Figure 45. THD+N vs. frequency

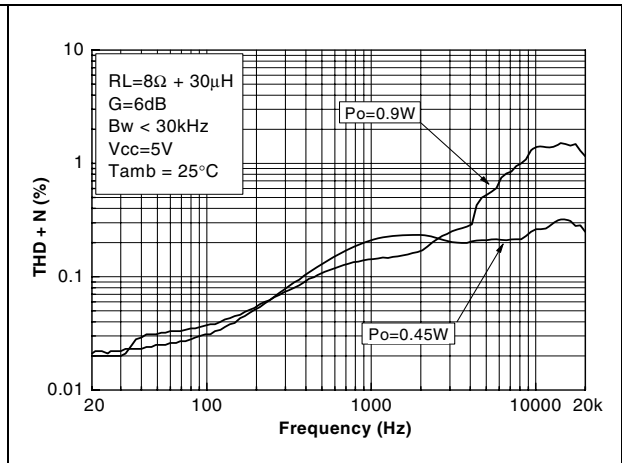

Figure 46. Power derating curves

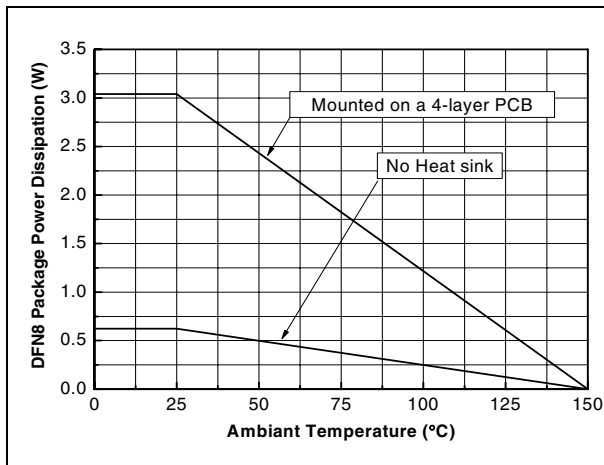

Figure 47. Startup and shutdown phase
 $V_{CC}=5\text{ V}$, $G=6\text{ dB}$, $C_{in}=1\text{ }\mu\text{F}$, inputs grounded

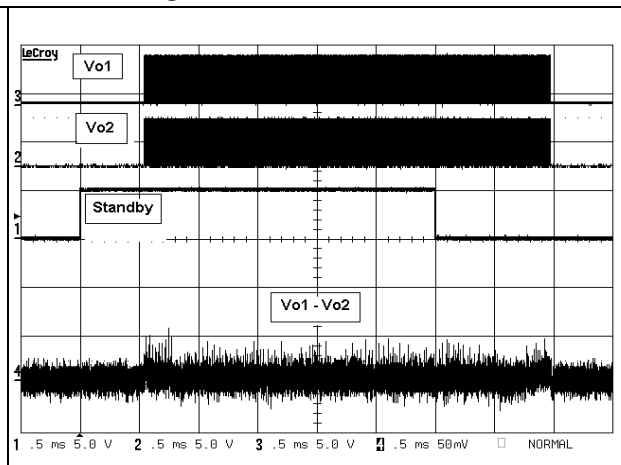

Figure 48. Startup and shutdown phase
 $V_{CC}=5\text{ V}$, $G=6\text{ dB}$, $C_{in}=1\text{ }\mu\text{F}$,
 $V_{in}=1\text{ V}_{pp}$, $F=10\text{ kHz}$

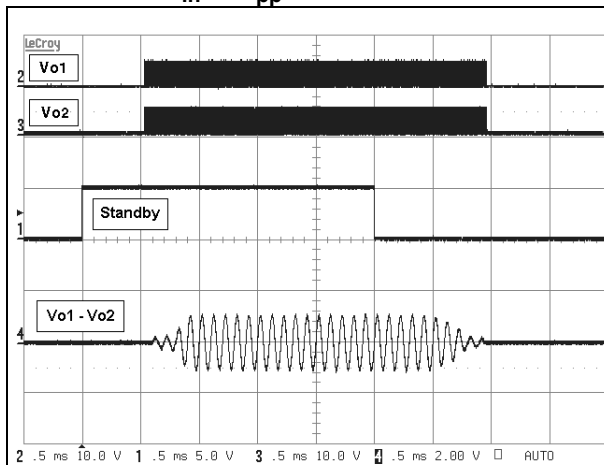
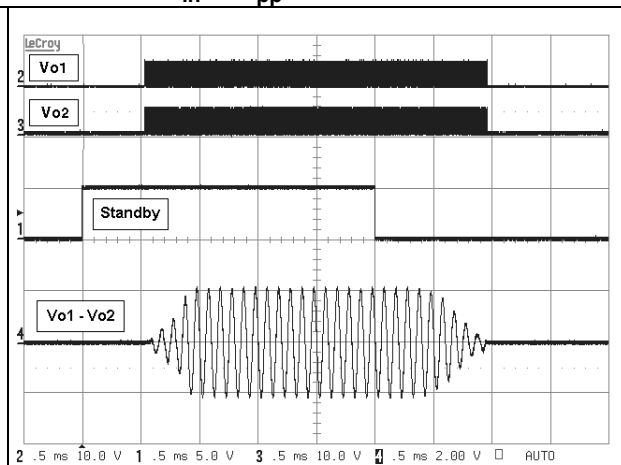

Figure 49. Startup and shutdown phase
 $V_{CC}=5\text{ V}$, $G=12\text{ dB}$, $C_{in}=1\text{ }\mu\text{F}$,
 $V_{in}=1\text{ V}_{pp}$, $F=10\text{ kHz}$



4 Application information

4.1 Differential configuration principle

The TS2007 is a monolithic fully-differential input/output class D power amplifier. The TS2007 also includes a common-mode feedback loop that controls the output bias value to average it at $V_{CC}/2$ for any DC common-mode input voltage. This allows the device to always have a maximum output voltage swing, and by consequence, maximize the output power. Moreover, as the load is connected differentially compared to a single-ended topology, the output is four times higher for the same power supply voltage.

The **advantages** of a full-differential amplifier are:

- High PSRR (power supply rejection ratio)
- High common-mode noise rejection
- Virtually zero pop without additional circuitry, giving a faster startup time compared to conventional single-ended input amplifiers
- Easier interfacing with differential output audio DAC
- No input coupling capacitors required thanks to common-mode feedback loop

4.2 Gain settings

In the flat region of the frequency-response curve (no input coupling capacitor or internal feedback loop + load effect), the differential gain can be set to either 6 or 12 dB depending on the logic level of the GS pin:

GS	Gain (dB)	Gain (V/V)
1	6 dB	2
0	12 dB	4

Note: Between the GS pin and V_{CC} there is an internal 300 k Ω resistor. When the pin is floating the gain is 6 dB.

4.3 Common-mode feedback loop limitations

As explained previously, the common-mode feedback loop allows the output DC bias voltage to be averaged at $V_{CC}/2$ for any DC common-mode bias input voltage.

Due to the V_{ic} limitation of the input stage (see [Table 2: Operating conditions on page 3](#)), the common-mode feedback loop can fulfill its role only within the defined range.

4.4 Low frequency response

If a low frequency bandwidth limitation is required, it is possible to use input coupling capacitors. In the low frequency region, the input coupling capacitor C_{in} starts to have an effect. C_{in} forms, with the input impedance Z_{in} , a first order high-pass filter with a -3 dB cutoff frequency (see [Table 5](#) to [Table 9](#)).

$$F_{CL} = \frac{1}{2 \cdot \pi \cdot Z_{in} \cdot C_{in}}$$

So, for a desired cutoff frequency F_{CL} we can calculate C_{in} :

$$C_{in} = \frac{1}{2 \cdot \pi \cdot Z_{in} \cdot F_{CL}}$$

with F_{CL} in Hz, Z_{in} in Ω and C_{in} in F.

The input impedance Z_{in} is for the whole power supply voltage range, typically 75 k Ω . There is also a tolerance around the typical value (see [Table 5](#) to [Table 9](#)). With regard to the tolerance, you can also calculate tolerance of F_{CL} :

- $F_{CLmax} = 1.103 \cdot F_{CL}$
- $F_{CLmin} = 0.915 \cdot F_{CL}$

4.5 Decoupling of the circuit

A power supply capacitor, referred to as C_S , is needed to correctly bypass the TS2007.

The TS2007 has a typical switching frequency of 280 kHz and output fall and rise time of about 5 ns. Due to these very fast transients, careful decoupling is mandatory.

A 1 μ F ceramic capacitor is enough, but it must be located very close to the TS2007 in order to avoid any extra parasitic inductance created by a long track wire. Parasitic loop inductance, in relation with di/dt, introduces overvoltage that decreases the global efficiency of the device and may cause, if this parasitic inductance is too high, a TS2007 breakdown.

In addition, even if a ceramic capacitor has an adequate high frequency ESR value, its current capability is also important. A 0603 size is a good compromise, particularly when a 4 Ω load is used.

Another important parameter is the rated voltage of the capacitor. A 1 μ F/6.3V capacitor used at 5 V, loses about 50% of its value. With a power supply voltage of 5 V, the decoupling value, instead of 1 μ F, could be reduced to 0.5 μ F. As C_S has particular influence on the THD+N in the medium to high frequency region, this capacitor variation becomes decisive. In addition, less decoupling means higher overshoots which can be problematic if they reach the power supply AMR value (6 V).

4.6 Wake-up time (t_{wu})

When the standby is released to set the device ON, there is a wait of 5 ms typically. The TS2007 has an internal digital delay that mutes the outputs and releases them after this time in order to avoid any pop noise.

Note: The gain increases smoothly (see [Figure 49](#)) from the mute to the gain selected by the GS pin ([Section 4.2](#)).

4.7 Shutdown time

When the standby command is set, the time required to put the two output stages into high impedance and to put the internal circuitry in shutdown mode, is typically 5 ms. This time is used to decrease the gain and avoid any pop noise during shutdown.

Note: The gain decreases smoothly until the outputs are muted (see Figure 49).

4.8 Consumption in shutdown mode

Between the shutdown pin and GND there is an internal 300 kΩ resistor. This resistor forces the TS2007 to be in shutdown when the shutdown input is left floating.

However, this resistor also introduces additional shutdown power consumption if the shutdown pin voltage is not 0 V.

Referring to Table 2: Operating conditions on page 3, with a 0.4 V shutdown voltage pin for example, you must add $0.4V/300k = 1.3 \mu A$ in typical ($0.4V/273 k = 1.46 \mu A$ in maximum) to the shutdown current specified in Table 5 to Table 9.

4.9 Single-ended input configuration

It is possible to use the TS2007 in a single-ended input configuration. However, input coupling capacitors are needed in this configuration. The following schematic diagram shows a typical single-ended input application.

Figure 50. Typical application for single-ended input configuration

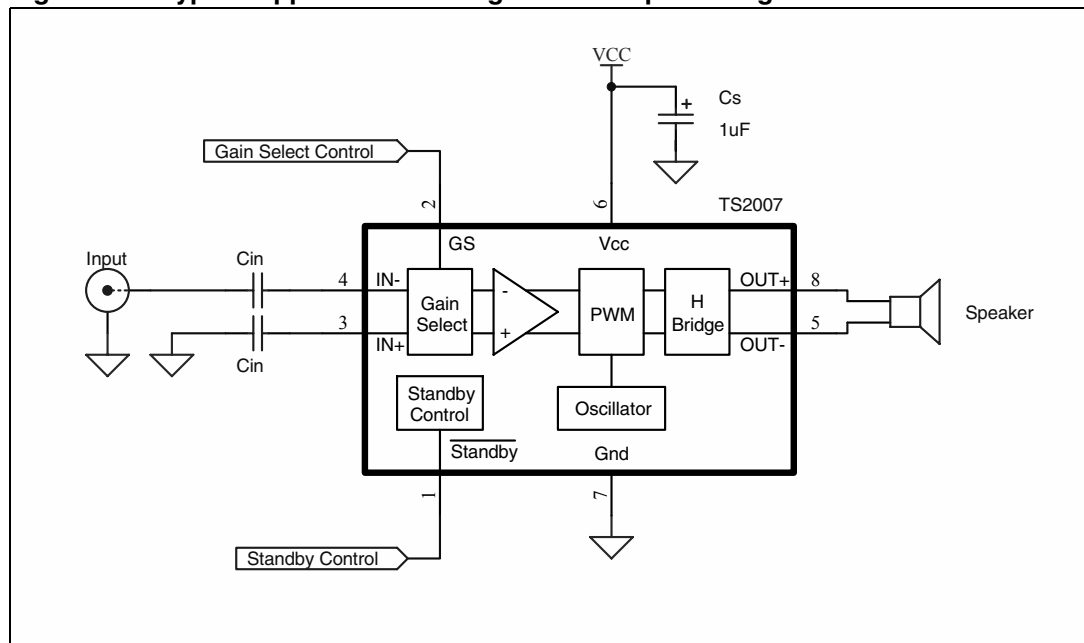

4.10 Output filter considerations

The TS2007 is designed to operate without an output filter. However, due to very sharp transients on the TS2007 output, EMI radiated emissions may cause some standard compliance issues.

These EMI standard compliance issues can appear if the distance between the TS2007 outputs and loudspeaker terminal are long (typically more than 50 mm, or 100 mm in both directions, to the speaker terminals). As the PCB layout and internal equipment device are different for each configuration, it is difficult to provide a one-size-fits-all solution.

However, to decrease the probability of EMI issues, there are several simple rules to follow:

- Reduce, as much as possible, the distance between the TS2007 output pins and the speaker terminals.
- Use a ground plane for “shielding” sensitive wires.
- Place, as close as possible to the TS2007 and in-series with each output, a ferrite bead with a rated current of minimum 2.5 A and impedance greater than 50 Ω at frequencies above 30 MHz. If, after testing, these ferrite beads are not necessary, replace them by a short-circuit.
- Allow extra footprint to place, if necessary, a capacitor to short perturbations to ground (see [Figure 51](#)).

Figure 51. Ferrite chip bead placement

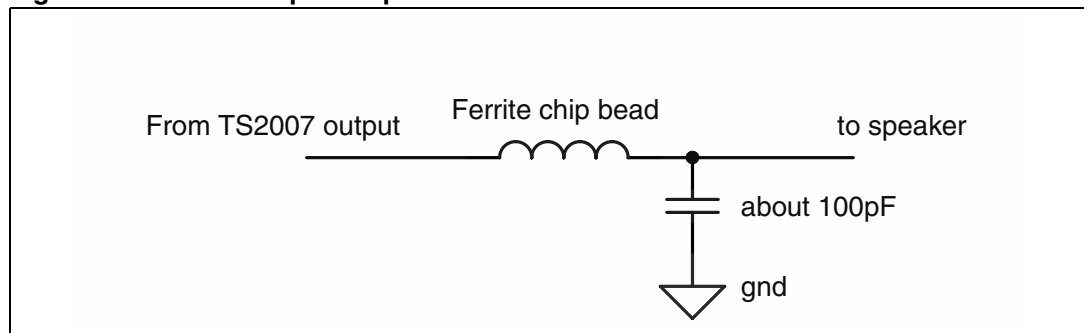

In the case where the distance between the TS2007 output and the speaker terminals is too long, it is possible to have low frequency EMI issues due to the fact that the typical operating frequency is 280 kHz. In this configuration, it is necessary to use the output filter represented in [Figure 1 on page 4](#) as close as possible to the TS2007.

5 Package information

In order to meet environmental requirements, STMicroelectronics offers these devices in ECOPACK® packages. These packages have a lead-free second level interconnect. The category of second level interconnect is marked on the package and on the inner box label, in compliance with JEDEC Standard JESD97. The maximum ratings related to soldering conditions are also marked on the inner box label. ECOPACK is an STMicroelectronics trademark. ECOPACK specifications are available at: www.st.com.

Figure 52. Pinout (top view)

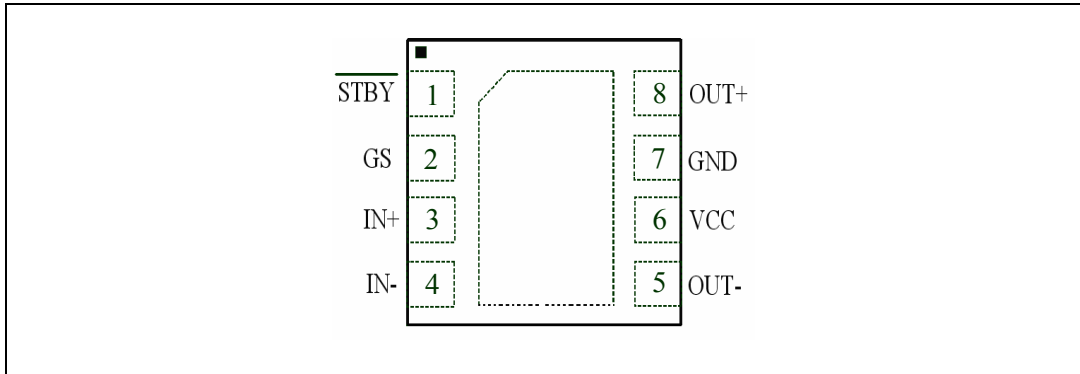

Figure 53. Marking (top view)

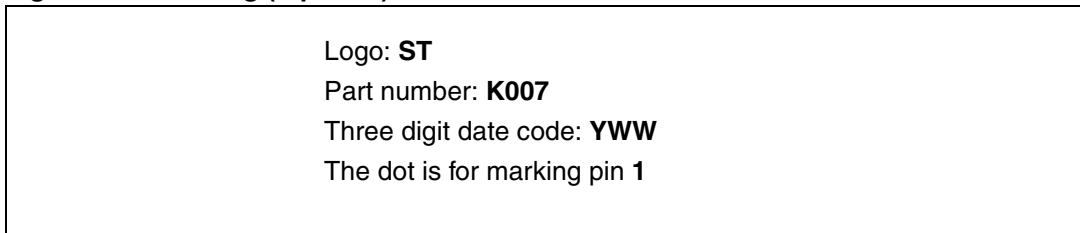

Figure 54. Recommended footprint for the TS2007 DFN8 package

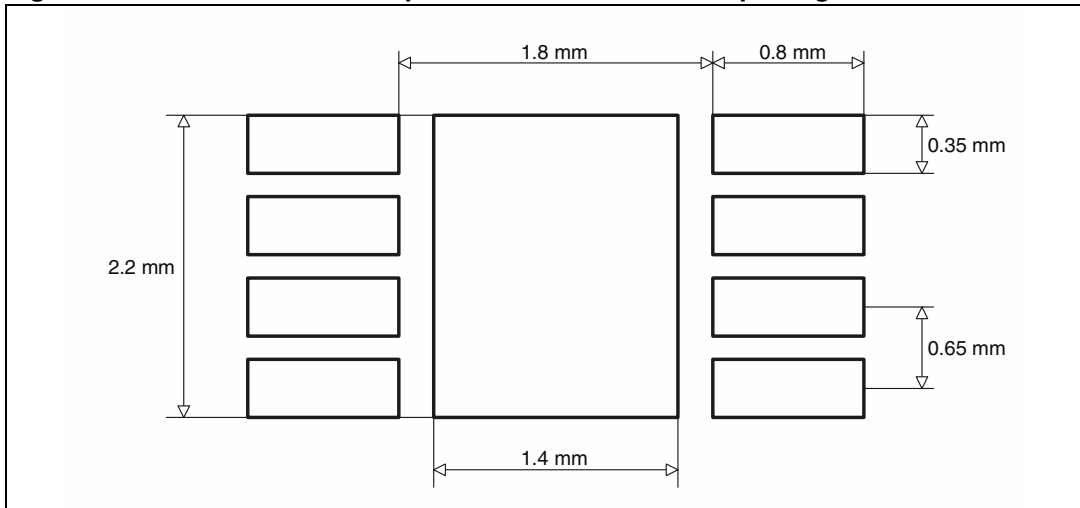
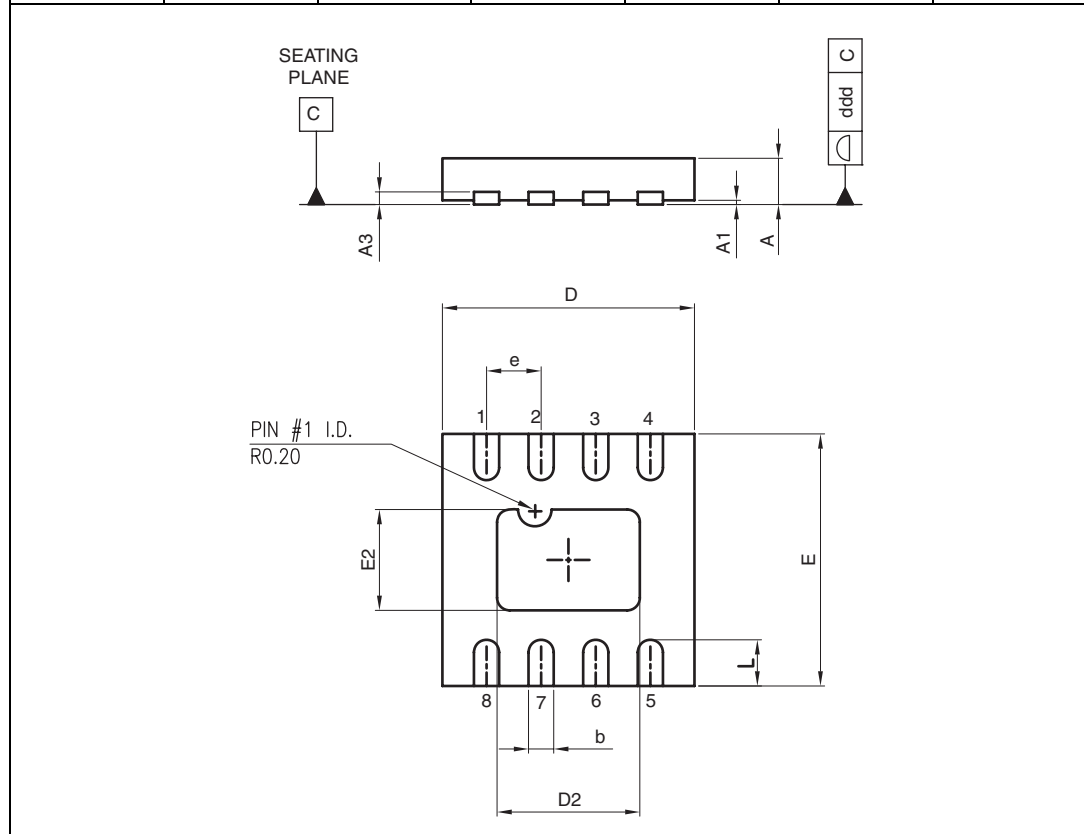

Figure 55. DFN8 package mechanical data

Ref	Dimensions					
	Millimeters			Mils		
	Min	Typ	Max	Min	Typ	Max
A	0.50	0.60	0.65	19.6	23.6	25.6
A1		0.02	0.05		0.8	1.9
A3			0.22			8.6
b	0.25	0.30	0.35	9.8	11.8	13.8
D	2.85	3.00	3.15	112.2	118.1	124
D2	1.60	1.70	1.80	63	66.9	70.8
E	2.85	3.00	3.15	112.2	118.1	124
E2	1.10	1.20	1.30	43.3	47.2	51.2
e		0.65			25.5	
L ⁽¹⁾	0.50	0.55	0.60	19.6	21.6	23.6
ddd			0.08			3.1



1. The dimension of L is not compliant with JEDEC MO-248 which recommends 0.40 mm +/-0.10 mm.

Note: The DFN8 package has an exposed pad E2 x D2. For enhanced thermal performance, the exposed pad must be soldered to a copper area on the PCB, acting as a heatsink. This copper area can be electrically connected to pin 7 or left floating.

6 Ordering information

Table 11. Order code

Part number	Temperature range	Package	Marking
TS2007IQT	-40 °C, +85 °C	DFN8	K07

7 Revision history

Date	Revision	Changes
11-Jan-2007	1	Initial release (preliminary data).
11-May-2007	2	First complete datasheet. This release of the datasheet includes electrical characteristics curves and application information.
24-May-2007	3	Corrected error in Table 4: Pin descriptions : descriptions of pin 5 and pin 8 were inverted.
02-May-2011	4	Added minimum R_L to Table 1: Absolute maximum ratings

Please Read Carefully:

Information in this document is provided solely in connection with ST products. STMicroelectronics NV and its subsidiaries ("ST") reserve the right to make changes, corrections, modifications or improvements, to this document, and the products and services described herein at any time, without notice.

All ST products are sold pursuant to ST's terms and conditions of sale.

Purchasers are solely responsible for the choice, selection and use of the ST products and services described herein, and ST assumes no liability whatsoever relating to the choice, selection or use of the ST products and services described herein.

No license, express or implied, by estoppel or otherwise, to any intellectual property rights is granted under this document. If any part of this document refers to any third party products or services it shall not be deemed a license grant by ST for the use of such third party products or services, or any intellectual property contained therein or considered as a warranty covering the use in any manner whatsoever of such third party products or services or any intellectual property contained therein.

UNLESS OTHERWISE SET FORTH IN ST'S TERMS AND CONDITIONS OF SALE ST DISCLAIMS ANY EXPRESS OR IMPLIED WARRANTY WITH RESPECT TO THE USE AND/OR SALE OF ST PRODUCTS INCLUDING WITHOUT LIMITATION IMPLIED WARRANTIES OF MERCHANTABILITY, FITNESS FOR A PARTICULAR PURPOSE (AND THEIR EQUIVALENTS UNDER THE LAWS OF ANY JURISDICTION), OR INFRINGEMENT OF ANY PATENT, COPYRIGHT OR OTHER INTELLECTUAL PROPERTY RIGHT.

UNLESS EXPRESSLY APPROVED IN WRITING BY AN AUTHORIZED ST REPRESENTATIVE, ST PRODUCTS ARE NOT RECOMMENDED, AUTHORIZED OR WARRANTED FOR USE IN MILITARY, AIR CRAFT, SPACE, LIFE SAVING, OR LIFE SUSTAINING APPLICATIONS, NOR IN PRODUCTS OR SYSTEMS WHERE FAILURE OR MALFUNCTION MAY RESULT IN PERSONAL INJURY, DEATH, OR SEVERE PROPERTY OR ENVIRONMENTAL DAMAGE. ST PRODUCTS WHICH ARE NOT SPECIFIED AS "AUTOMOTIVE GRADE" MAY ONLY BE USED IN AUTOMOTIVE APPLICATIONS AT USER'S OWN RISK.

Resale of ST products with provisions different from the statements and/or technical features set forth in this document shall immediately void any warranty granted by ST for the ST product or service described herein and shall not create or extend in any manner whatsoever, any liability of ST.

ST and the ST logo are trademarks or registered trademarks of ST in various countries.

Information in this document supersedes and replaces all information previously supplied.

The ST logo is a registered trademark of STMicroelectronics. All other names are the property of their respective owners.

© 2011 STMicroelectronics - All rights reserved

STMicroelectronics group of companies

Australia - Belgium - Brazil - Canada - China - Czech Republic - Finland - France - Germany - Hong Kong - India - Israel - Italy - Japan - Malaysia - Malta - Morocco - Singapore - Spain - Sweden - Switzerland - United Kingdom - United States of America

www.st.com

